

Super High Power LED Headlight/Headlamp **NEW**

- LED** 2 High Power LEDs, 12~36V
- Size**..... 6 1/2" (L) x 4 1/4" (W) x 4 3/4" (D)
- Material** Rugged heavy duty design with aluminum black powder coated housing and stainless steel adjustable mounting hardware
- Features** 12V: 2.1 AMP/24V: 1.1 AMP
Retrofit/Interchange: HP4651, H4656
- Wire Connection** Plug & Go Adapter (Included)
- Unit & Package** Sold by each, color display pack
- Patent** Pending



U.S. PATENT PENDING



Side



| Part No. | Beam |
|----------|-----------|
| 77405 | Low Beam |
| 77406 | High Beam |



Back



Back w/Adaptor

#77405 Light Output View

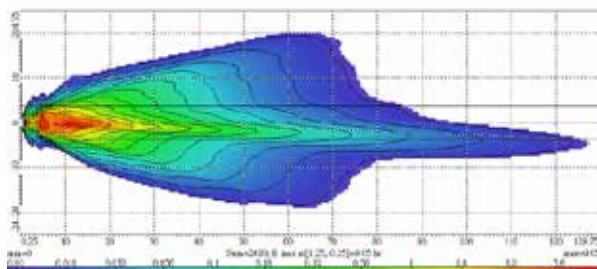

#77406 Light Output View

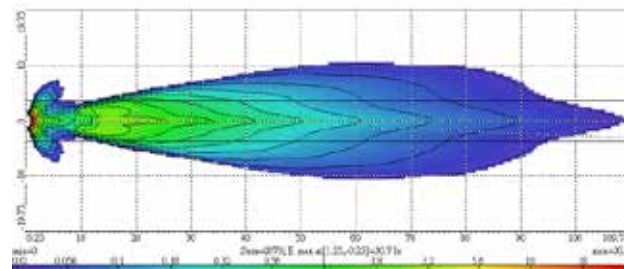

4" Prime Spyder LED Sealed Light **NEW**

- LED** 17 LEDs - 12V
- Size** 4 5/16" Dia. x 1 1/8" (W)
- Material** Polycarbonate lens, reflector and housing are sonically sealed
- Wire Connection** #87368 Plug Included
- Unit & Package** Sold by each, carded for display
- Patent** Pending



U.S. PATENT PENDING

| Light Only | LED/Lens Color | Light Only | LED/Lens Color |
|------------|----------------|------------|----------------|
| 74870 | Amber/Amber | 74872 | Red/Red |
| 74871 | Amber/Clear | 74873 | Red/Clear |

NEW DISPLAY "TRY ME" PACKAGING!



PUSH ON & OFF BUTTON

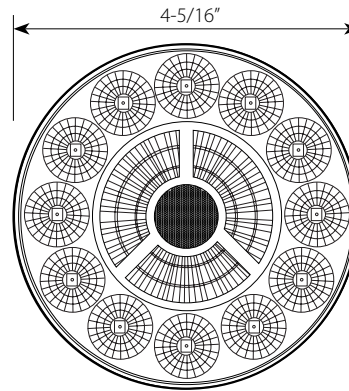

Front view

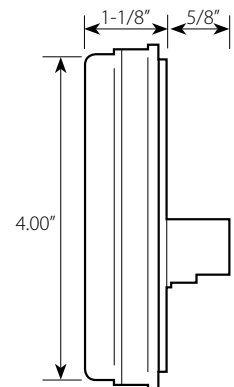

Side view

Colors Available



Amber/Amber



Amber/Clear



Red/Red



Red/Clear

4" Prime LED Sealed Light **NEW**

LED 7 LEDs - 12V
Size 4 5/16" Dia. x 1 3/8" (W)
Material Polycarbonate lens, reflector and housing are sonically sealed
Wire Connection #87368 Plug Included
Unit & Package Sold by each, carded for display
Patent Pending



U.S. PATENT PENDING



| Light Only | LED/Lens Color |
|------------|----------------|
| 74880 | Red/Red |
| 74881 | Red/Clear |

NEW DISPLAY "TRY ME" PACKAGING!



PUSH ON & OFF BUTTON

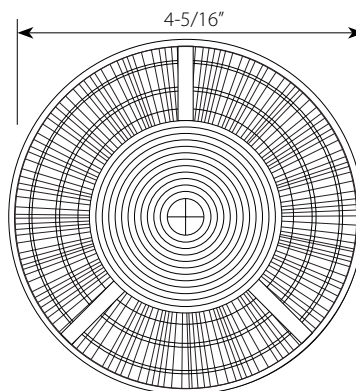

Front View

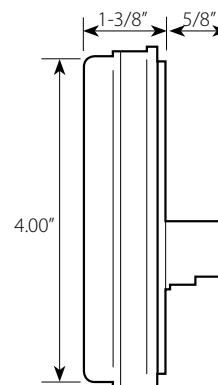

Side View

Colors Available



Red/Red



Red/Clear

4" Smart Dynamic LED Sealed Light **NEW**

Turn Signal Sequential Pattern

- LED** 26 LEDs - 12V
- Size** 4 5/16" Dia. x 1 1/8" (W)
- Material** Polycarbonate lens, reflector and housing are sonically sealed
- Wire Connection** #87368 Plug Included
- Additional** Built-In Smart Chip to Sense Turn or Stop Signal
Stop Function: Full Lit (Non-Sequential)
- Unit & Package** Sold by each, carded for display
- Patent** Pending



U.S. PATENT PENDING

| Part No. | LED/Lens Color | Part No. | LED/Lens Color |
|----------|----------------|----------|----------------|
| 74890 | Amber/Amber | 74892 | Red/Red |
| 74891 | Amber/Clear | 74893 | Red/Clear |

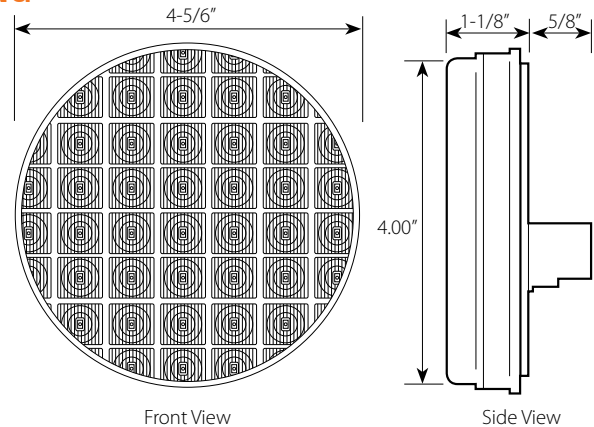

NEW DISPLAY "TRY ME" PACKAGING!

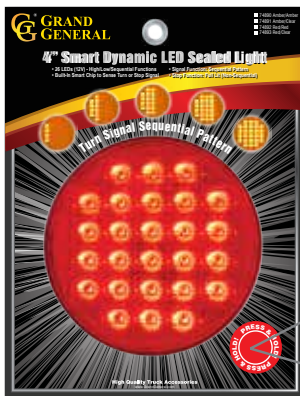

PUSH ON & OFF BUTTON



Turn Signal Sequential Pattern

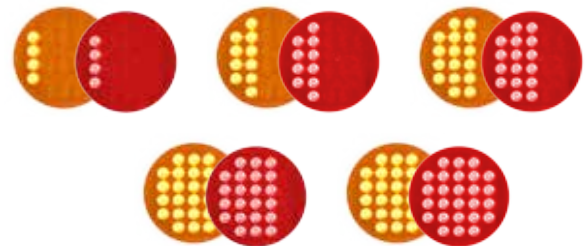

Colors Available



Amber/Amber

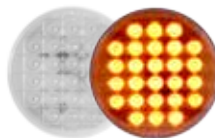

Amber/Clear



Red/Red

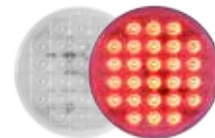

Red/Clear

6-1/4" Ultra Thin LED Light Bar **NEW**

Marker/Clearence (Single Function)

LED 6 LEDs - 12V

Size Light: 6 1/4" (L) x 9/16" (W) x 1/4" (H)

Bezel: 6 1/2" (L) x 7/8" (W) x 3/8" (H)

Material Sealed lens with chrome plastic bezel

Wire Connection 2 wires, hardwired, with ground ring

Unit & Package Sold by each, carded for display



DOT
PENDING

| w/ Chrome Plastic Bezel | Light Only | LED/Lens Color |
|-------------------------|------------|----------------|
| 76040 | 76030 | Amber/Amber |
| 76041 | 76031 | Amber/Clear |
| 76042 | 76032 | Blue/Blue* |
| 76043 | 76033 | Green/Green* |
| 76044 | 76034 | Red/Red |
| 76045 | 76035 | Red/Clear |
| 76046 | 76036 | White/Clear* |

* Does not meet DOT specs. White, blue and green lights designed for interior use only.

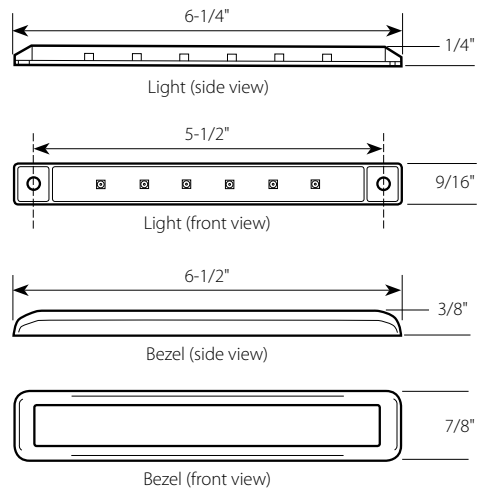

Colors Available/Replacement Parts

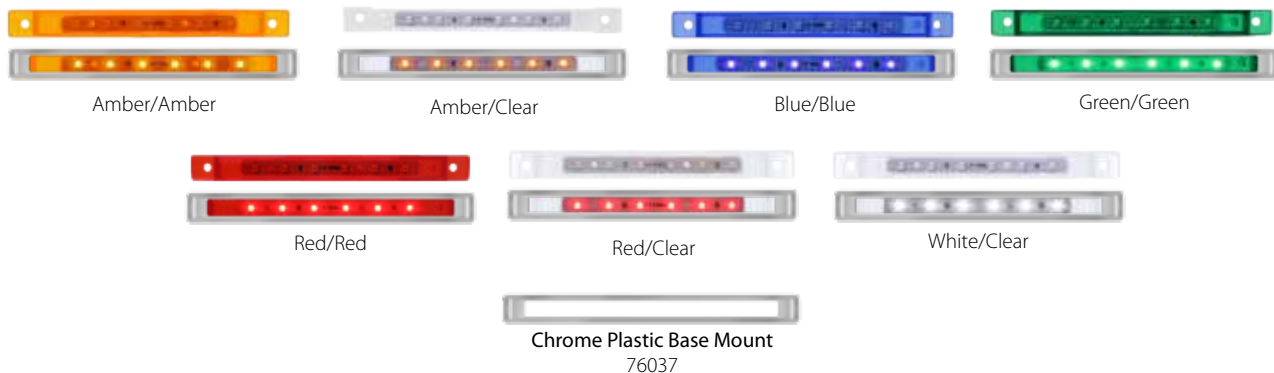

2" Round Dual Function LED Light

LED 6 LEDs - 12V
Size 2" Dia. x 5/8" (H)
Wire Connection 3 Wires, hardwired, with ground ring
Unit & Package Sold by each, carded for display.

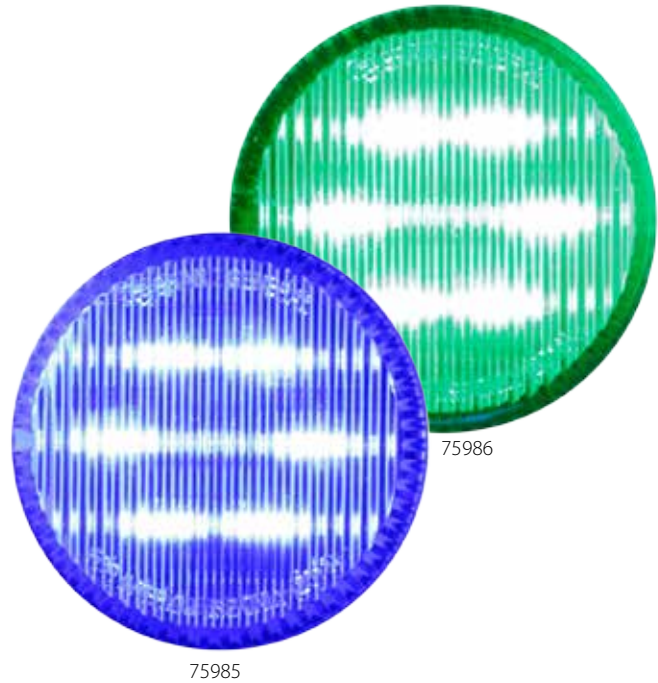

| Part No. | LED/Lens Color |
|----------|----------------|
| 75980 | Amber/Amber |
| 75981 | Amber/Clear |
| 75982 | Red/Red |
| 75983 | Red/Clear |
| 75984 | White/Clear* |
| 75985 | Blue/Blue* |
| 75986 | Green/Green* |

NEW

* Does not meet DOT specs. White, blue and green lights designed for interior use only.

Heavy Duty LED Flasher

Features Variable load 12V
Unit & Package Sold by each, color display pack

| Part No. | Description |
|----------|--|
| 62990 | Round, 2 Pin, Max 25 AMPS |
| 62991 | Rectangular, 2 Pin, Max 25 AMPS |
| 62992 | Rectangular, 2 Pin, Max 35 AMPS |
| 62993 | Heavy Duty LED Flasher Rectangular, 2 Pin w/5" Ground Wire, Max 20 AMPS |

NEW

